



# CGC Suspended Ceiling System Quick Start Guide

CGC suspended ceilings are finished to complement your room decor. CGC suspended ceilings offer many advantages such as easy access to plumbing and wiring, fire resistance and sound insulation. See specific product ratings for more information.

## Getting Started

Here's what you'll need.

### Tools & equipment:

- 6' step ladder
- Tape measure
- Pencil
- Graph paper
- Hammer
- Power screwdriver
- Drill
- Metal snips
- Chalk line
- Level (ideally a laser level)
- Pliers
- Utility knife
- Safety glasses
- String
- Clamps

### Fasteners:

- [No. 12] screws (wood or concrete) to attach wall angles to walls
- [No. 10] lag screws (wood) for hanging main tees from joists
- Steel wire for hanging CGC DOWN® Brand main tees (18-gauge for residential, 12-gauge for commercial)

## Know your components

For best results use CGC DOWN Brand suspension systems.

There are four main components to a suspended ceiling:

**1. DOWN Brand Wall Angle** (available in 10' length only) [Illustration 1]

L-shaped moulding that supports and finishes the ceiling around its perimeter.

**2. DOWN Brand Main Tees** (available in 8' and 12' lengths) [Illustration 2]

The primary support for the ceiling system, main tees run the length of the room suspended from the joists by wire hangers. Main tees are punched for cross tee installation 3" from ends and then 6" on centre.

**3. DOWN Brand Cross Tees** [Illustration 3]

Cross tees are the supports that connect the main tees in a grid pattern to receive the ceiling panels. They are available in two lengths:

- 4' cross tees – Used for 2'x4' and 2'x2' ceiling panels
- 2' cross tees – Required for 2'x2' ceiling panels

### 4. CGC Ceiling panels

Ceiling panels come in two sizes:

- 2' x 4' and 2' x 2'

'Directional' ceiling panels have arrows printed on the back.

They must be installed with all arrows pointing in the same direction for a consistent pattern.

## Typical Installation

2'x4' grid layout (shown right).

### Contractor's tip:

The 2'x4' pattern is more economical, easier to plan and faster to install. The following easy steps will help you plan and install your suspended ceiling.

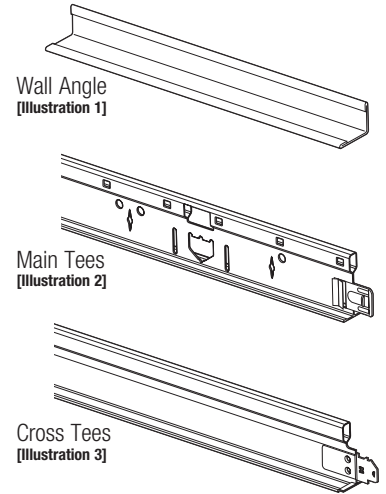

2' x 4' Tee Layout

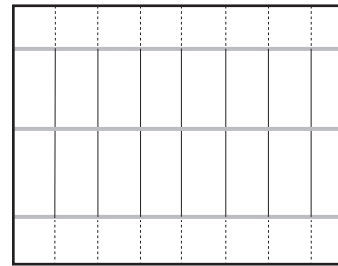

2' x 2' Tee Layout

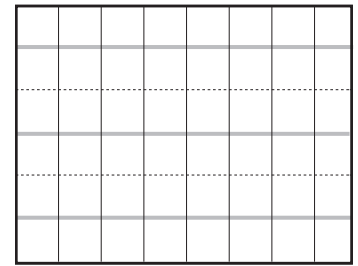

— Wall Angle — 4' Cross Tees  
— Main Tees - - - - - 2' Cross Tees

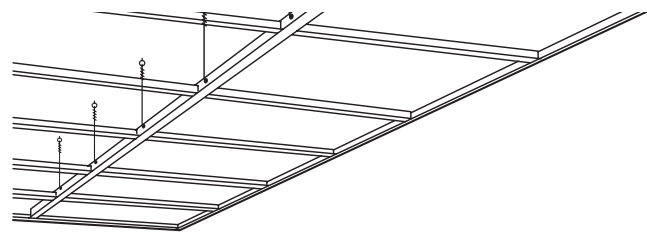

## Step 1: Measure and plan

Create a scale diagram of the ceiling on graph paper. Careful planning and measurement at the beginning will reduce errors and wastage.

1. Measure each wall at the highest possible ceiling height (min. 4" below lowest obstruction) including any irregular areas such as alcoves or stairwells.

For best appearance, ensure perimeter panels are as large as possible and equal in size.

2. Transfer your room measurements to a diagram on graph paper with a convenient scale, such as one square equals one square foot.

3. On your diagram, draw the correct positions of all overhead lights, air vents, columns, and/or other fixtures the ceiling must accommodate.

4. Plot main framing lines on the diagram. Draw the room centreline which is parallel to the long walls and perpendicular to the joists of the floor above.

From this centreline, in both directions, draw parallel lines at each 4' interval. If the margin between the last line and the sidewall is less than 2', redraw the lines starting 2' on either side of the centreline (still at 4' intervals).

5. Plot cross framing lines on the diagram. Establish and draw a centreline in the other direction (from sidewall to sidewall). You have now identified the centre point of the room. From this point, in both directions, draw parallel lines at every 2' interval (to the endwalls).

6. Make sure that no lights or air vents are blocked by your framing pattern. If they are, either move them or your framing pattern.

## Step 2: Estimate your materials

Using the measurements from your graph paper diagram, estimate materials with the chart below.

Room Size	2' x 2' layout			2' x 4' layout		10' Wall angle	8' or 12' Main tees
	2' x 2' Panels	2' Cross Tees	4' Cross Tees	2' x 4' Panels	4' Cross Tees		
8' x 10'	20	10	8	10	8	4	2 or 1
10' x 10'	25	10	10	15	12	4	3 or 2
10' x 16'	40	16	18	24	21	6	4 or 3
12' x 16'	48	24	21	24	21	6	4 or 3
12' x 20'	60	30	27	30	27	7	5 or 4

This chart is based on main tees running the width of the room. Information is approximate and is for estimating only. Materials purchased should be based on specific room size take-offs.

## Estimating Tips

Example: 48'x20' room = 960 sq. ft.

2'x2' panels = 960 sq. ft. divided by 4 sq. ft. = 240 panels

2'x4' panels = 960 sq. ft. divided by 8 sq. ft. = 120 panels

Main Tees = 960 sq. ft. x .250 = 240 lineal feet = 20 pcs 12' Main Tees or 30 pcs 8' Main Tees

4' Cross Tees = 960 sq. ft. x .500 = 480 lineal feet = 120 pcs 4' Cross Tees

2' Cross Tees = 960 sq. ft. x .250 = 240 lineal feet = 120 pcs 2' Cross Tees

Wall mould = 960 sq. ft. x .150 = 144 lineal feet = 15 pcs 10' Wall mould

Note: Remove 2' Cross Tees step if installing a 2'x4' ceiling.

Continued on reverse...

### Step 3: Install your ceiling

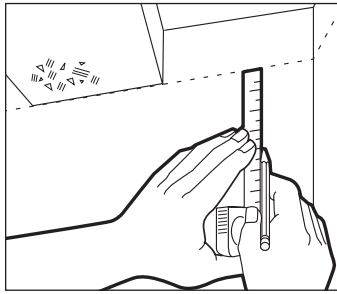

**1. Determine the highest possible ceiling height for your room.** The entire ceiling must be one consistent height at least 4" below the lowest obstruction. At this height, make a series of level marks a few inches apart around the entire perimeter of the room. **Tip:** A laser level can be very helpful with this step.

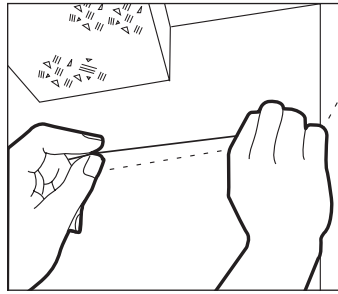

**2. Mark the perimeter of the room.** Connect your level marks at ceiling height with a chalk line as a guide for installing the wall angle.

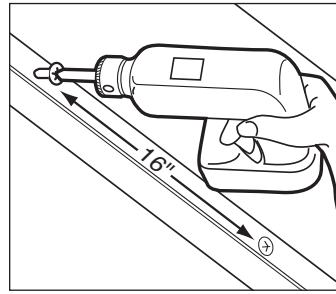

**3. Install wall angle.** Place the bottom of the wall angle moulding along the perimeter line and fasten it to the wall with screws 16" on centre to follow your stud framing pattern.

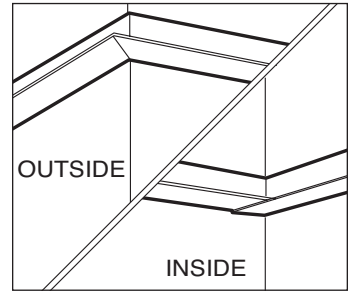

**4. Cut the wall angle corners.** Use metal snips to mitre outside corners 45 degrees. For inside corners simply cut at 90 degrees and overlap the bottom ledge. **Tip:** Use a framing square to accurately mitre a corner.

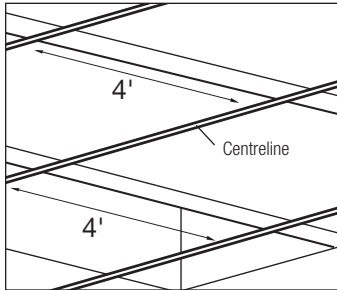

**5. Mark main tees perpendicular to joist.** Referring to your diagram, stretch a string across the room at ceiling height to locate your centreline main tee. From this centreline, in both directions, mark main tees at 4' intervals on centre.

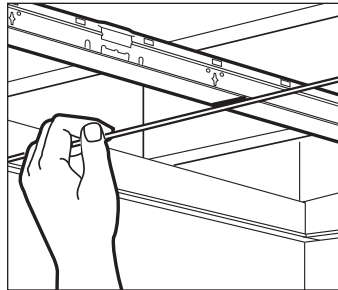

**6. Mark cross tees.** Referring to your diagram, stretch a taut string from the centre point of the cross tee wall which is parallel to the joist.

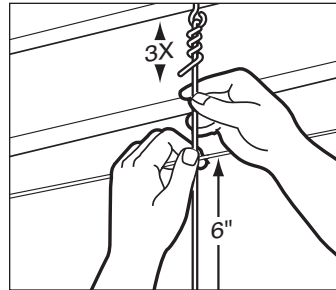

**7. Install hanger wires.** Along each main tee string line, twist lag screws into the bottoms of the wood joists 4' apart. Wrap hanger wire 3 times around lag screw and cut 6" below the string line.

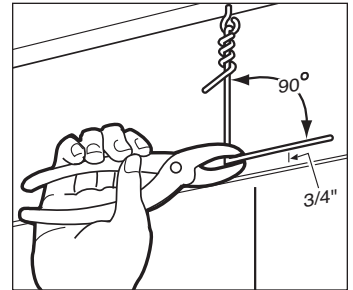

**8. Bend hanger wires.** With pliers, make a 90 degree bend in each hanger wire 3/4" above the string line.

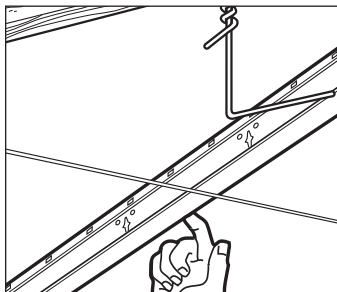

**9. Position main tees.** Position and trim the centreline main tee so that a cross tee hole is aligned with the centre point of the room. **Tip:** Main tees should be trimmed by 1/8" on each end to allow for minor grid shifting.

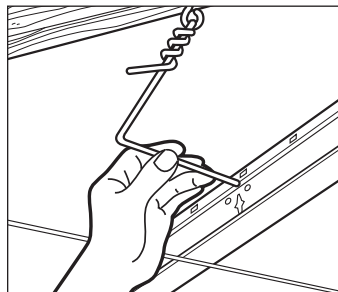

**10. Hang main tees.** Pull each hanger wire through the hanger wire hole in the main tee. After making sure the main tee is level, continue bending the 90 degree angle upward, and then wrap it tightly 3 times around itself.

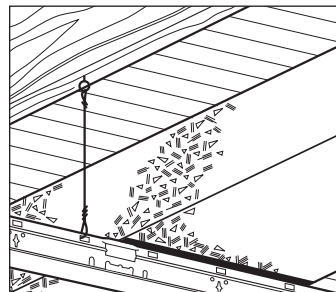

**Attention:** If lights or vents interfere with access to the lower round hole for hanging, use one of the other convenience holes in the main tee.

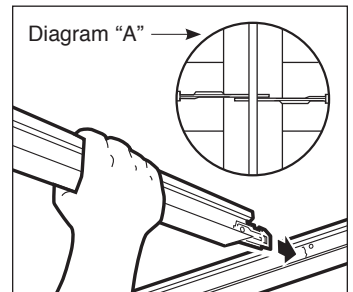

**11. Install cross tees.** Hold the end of each cross tee above the hanging main tee and gently push it down into the fitting. At the other end, push the cross tee sideways through the hole in the main tee stem until you hear it click. **Attention:** Insert cross tees into main tees with locking clip on left side (see Diagram "A").

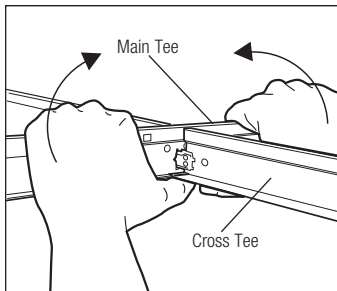

**Attention:** If necessary, detach a cross tee by lifting up on the main tee and quickly rotating it away from the cross tee until it pops out.

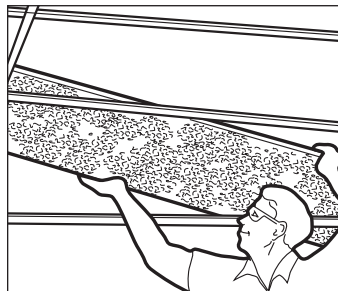

**12. Lay in ceiling panels.** Angle panels through the opening, then straighten and lower until they rest evenly on the tees. **Attention:** Perimeter panels should be installed first, followed by the full sized panels.

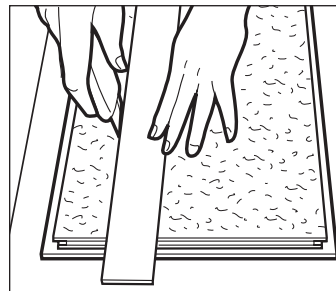

**Attention:** When panels need to be cut to fit smaller openings next to walls, measure the opening carefully and cut into the face of the tile using a straightedge and sharp utility knife.

### Helpful tips for problem free installation



**INSTALLING LIGHT FIXTURES**  
Plan the kind of overhead lighting you want for the room and install it completely before you begin installing the ceiling. Translucent ceiling panels can pass light through from fluorescent light fixtures attached to the joists (never the ceiling framework). Pot lighting must be positioned and installed through holes in the ceiling panels. **Attention!** Pot lighting should not be supported by ceiling panels. Proper pot lighting fixtures with adjustable rails should be used for suspended ceilings.

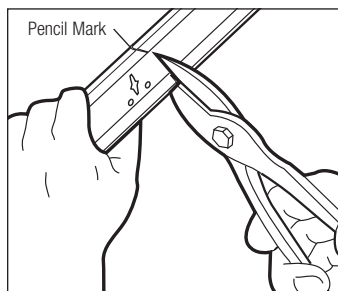

**CUTTING TEES**  
Cut tees with metal snips stem-first, then bend the tee away from the cut and snip the flanges. Use a file to remove burrs and rough edges.

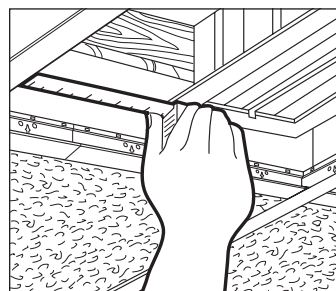

**INSTALLING AROUND OBSTRUCTIONS**  
Draw the shape of the obstruction in the right location on the panel and cut it out from the face side with a utility knife. In the case of a pole/column, cut from the hole to one side, or to both sides if necessary and install the panel in two pieces.

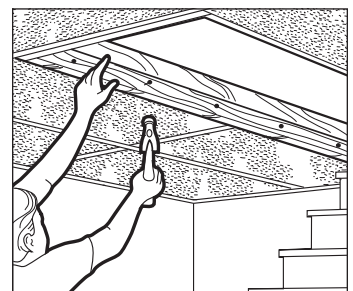

**BUILDING A VALANCE**  
When a stairwell or window opening extends above the ceiling plan, build a valance with 3/4" lumber and attach the ceiling the way you would to a wall.

**Safety First** At all times, exercise caution while using power tools and/or standing on ladders. Using an assistant is highly recommended. Take necessary precautions and wear the right personal protective equipment for the job. Read material safety data sheets and related literature on products before specification and/or installation.

**Congratulations you have just installed a high quality CGC ceiling system. Thank you for using CGC products!**



CGC Inc.  
350 Burnhamthorpe Rd. W., 5th Floor  
Mississauga, ON L5B 3J1

www.cgcinc.com

EGR\_OG14/03-14  
©2014, CGC Inc., MS  
Printed in Canada